

LRXI Industrial Fiber Extender

**Extend high resolution digital video, USB, audio
and serial signals reliably up to 2.5 miles.**

Uses fiber optic links to ensure immunity from interference.



Trademarks Used in this Manual

Black Box and the Double Diamond logo are registered trademarks of BB Technologies, Inc.

Any other trademarks mentioned in this manual are acknowledged to be the property of the trademark owners.

We're here to help! If you have any questions about your application or our products, contact Black Box Tech Support at **877-877-2269** or go to **blackbox.com** and click on "Talk to Black Box." You'll be live with one of our technical experts in less than 60 seconds.

Federal Communications Commission and Industry Canada Radio Frequency Interference Statements

This equipment generates, uses, and can radiate radio-frequency energy, and if not installed and used properly, that is, in strict accordance with the manufacturer's instructions, may cause interference to radio communication. It has been tested and found to comply with the limits for a Class A computing device in accordance with the specifications in Subpart B of Part 15 of FCC rules, which are designed to provide reasonable protection against such interference when the equipment is operated in a commercial environment. Operation of this equipment in a residential area is likely to cause interference, in which case the user at his own expense will be required to take whatever measures may be necessary to correct the interference.

Changes or modifications not expressly approved by the party responsible for compliance could void the user's authority to operate the equipment.

This digital apparatus does not exceed the Class A limits for radio noise emission from digital apparatus set out in the Radio Interference Regulation of Industry Canada.

Le présent appareil numérique n'émet pas de bruits radioélectriques dépassant les limites applicables aux appareils numériques de la classe A prescrites dans le Règlement sur le brouillage radioélectrique publié par Industrie Canada.

Disclaimer:

Black Box Network Services shall not be liable for damages of any kind, including, but not limited to, productive, consequential or cost of cover damages, resulting from any errors in the product information or specifications set forth in this document and Black Box Network Services may revise this document at any time without notice.

Instrucciones de Seguridad

(Normas Oficiales Mexicanas Electrical Safety Statement)

1. Todas las instrucciones de seguridad y operación deberán ser leídas antes de que el aparato eléctrico sea operado.
2. Las instrucciones de seguridad y operación deberán ser guardadas para referencia futura.
3. Todas las advertencias en el aparato eléctrico y en sus instrucciones de operación deben ser respetadas.
4. Todas las instrucciones de operación y uso deben ser seguidas.
5. El aparato eléctrico no deberá ser usado cerca del agua—por ejemplo, cerca de la tina de baño, lavabo, sótano mojado o cerca de una alberca, etc.
6. El aparato eléctrico debe ser usado únicamente con carritos o pedestales que sean recomendados por el fabricante.
7. El aparato eléctrico debe ser montado a la pared o al techo sólo como sea recomendado por el fabricante.
8. Servicio—El usuario no debe intentar dar servicio al equipo eléctrico más allá a lo descrito en las instrucciones de operación. Todo otro servicio deberá ser referido a personal de servicio calificado.
9. El aparato eléctrico debe ser situado de tal manera que su posición no interfiera su uso. La colocación del aparato eléctrico sobre una cama, sofá, alfombra o superficie similar puede bloquea la ventilación, no se debe colocar en libreros o gabinetes que impidan el flujo de aire por los orificios de ventilación.
10. El equipo eléctrico deber ser situado fuera del alcance de fuentes de calor como radiadores, registros de calor, estufas u otros aparatos (incluyendo amplificadores) que producen calor.
11. El aparato eléctrico deberá ser conectado a una fuente de poder sólo del tipo descrito en el instructivo de operación, o como se indique en el aparato.
12. Precaución debe ser tomada de tal manera que la tierra física y la polarización del equipo no sea eliminada.
13. Los cables de la fuente de poder deben ser guiados de tal manera que no sean pisados ni pellizcados por objetos colocados sobre o contra ellos, poniendo particular atención a los contactos y receptáculos donde salen del aparato.
14. El equipo eléctrico debe ser limpiado únicamente de acuerdo a las recomendaciones del fabricante.
15. En caso de existir, una antena externa deberá ser localizada lejos de las líneas de energía.
16. El cable de corriente deberá ser desconectado del cuando el equipo no sea usado por un largo periodo de tiempo.
17. Cuidado debe ser tomado de tal manera que objetos líquidos no sean derramados sobre la cubierta u orificios de ventilación.
18. Servicio por personal calificado deberá ser provisto cuando:
 - A: El cable de poder o el contacto ha sido dañado; u
 - B: Objetos han caído o líquido ha sido derramado dentro del aparato; o
 - C: El aparato ha sido expuesto a la lluvia; o
 - D: El aparato parece no operar normalmente o muestra un cambio en su desempeño; o
 - E: El aparato ha sido tirado o su cubierta ha sido dañada.

Contents

1. Specifications..... 6

2. Welcome..... 7

 2.1 LRXI Industrial Fiber Extender features 8

3. Locations..... 10

 3.1 Connections..... 10

 3.2 Fiber optic link 11

 3.3 Local unit video link 13

 3.4 Local unit audio links 13

 3.5 Local unit USB link 14

 3.6 Local unit serial link..... 14

 3.7 Local unit management port link 15

 3.8 Local unit power connection 16

 3.9 Remote unit video display 18

 3.10 Remote unit audio devices 19

 3.11 Remote unit USB devices 20

 3.12 Remote unit serial link 21

 3.13 Remote unit power connection 22

4. Accessing the management application 24

 4.1 To access the management application..... 24

 4.2 To temporarily connect a computer to the network port..... 24

 4.3 The Configure page..... 25

 4.4 The Maintenance page 26

5. Operation..... 28

 5.1 Indicators 28

 5.2 Resetting a unit 29

Appendix A. Options port pin-out 30

Appendix B. Open source licenses 31

Appendix C. Safety Information 32

1. Specifications

Approvals: CE, FCC

Hardware Compatibility: All computers with DVI-D digital video and USB interfaces

Software Compatibility: Operates with all known software and operating systems including Windows®, Linux®, Unix®, BSD, all Sun® OS, all Mac® OS, NetWare®, etc.

Operating Temperature: 32 to 104°F (0 to 40°C)

2. Welcome

Thank you for choosing the LRXI Industrial Fiber Extender (ACU5600A) units. Using fiber optic links, these compact units allow you to transfer the multiple connections listed below up to 2.5 miles (4 kilometers) from a host computer (see Transmission distances below).

The high grade screening employed within the metal cased enclosures combined with the immunity from interference of the fiber optic links make the LRXI Industrial Fiber Extender units highly suitable for use in 'noisy' industrial environments.

LRXI Industrial Fiber Extender units provide support for:

- High quality single- or dual-link DVI digital video (up to 2560 x 2048 @60Hz),
- USB keyboard and mouse plus two other USB devices (up to USB 2.0),
- An RS232 serial device at speeds up to 115200 baud,
- Mono microphone,
- Stereo speakers,
- Line-level audio in/out connections.

The LRXI Industrial Fiber Extender units are totally transparent in operation, leaving you free to use your computer as though you're still sitting next to it.

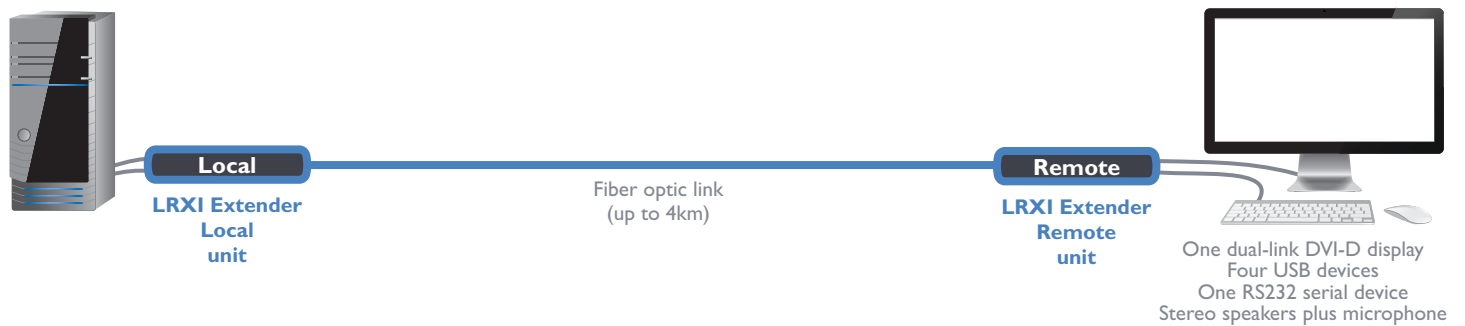

Transmission distances

The choice of fiber used with the LRXI Industrial Fiber Extender units has a considerable effect on the distance over which operation can take place. Using multi-mode fiber you can achieve distances up to 400m (1,312 feet); whereas, by using single-mode fiber (and accompanying SFP modules), the achievable maximum distance is increased to 2.5 miles (4km):

Distance	Fiber type	Fiber color code	SFP module	SFP bar color
70m	OM1 (TIA-492AAAA)	Orange	ACUSFP-MM-10G	Black
150m	OM2 (TIA-492AAAB)	Orange	ACUSFP-MM-10G	Black
380m	OM3 (TIA-492AAAC)	Aqua	ACUSFP-MM-10G	Black
400m	OM4 (TIA-492AAAC)	Aqua	ACUSFP-MM-10G	Black
4km	OS1 (TIA-492C000)	Yellow	ACUSFP-SM-10G	Blue
	OS2 (TIA-492E000)	Yellow	ACUSFP-SM-10G	Blue

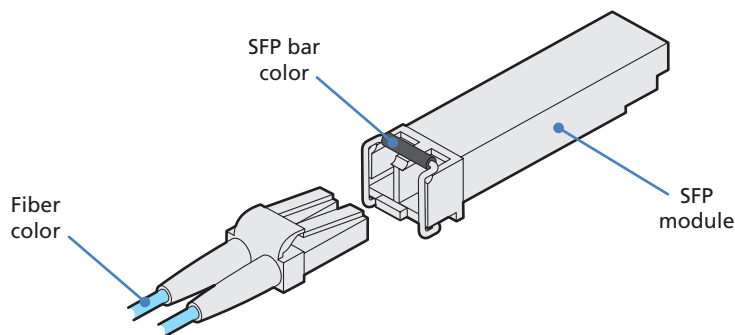

2.1 LRXI Industrial Fiber Extender features

The local and remote units are contained within slimline metal casings that measure just 169 x 120 x 31mm.

2.1.1 Local unit

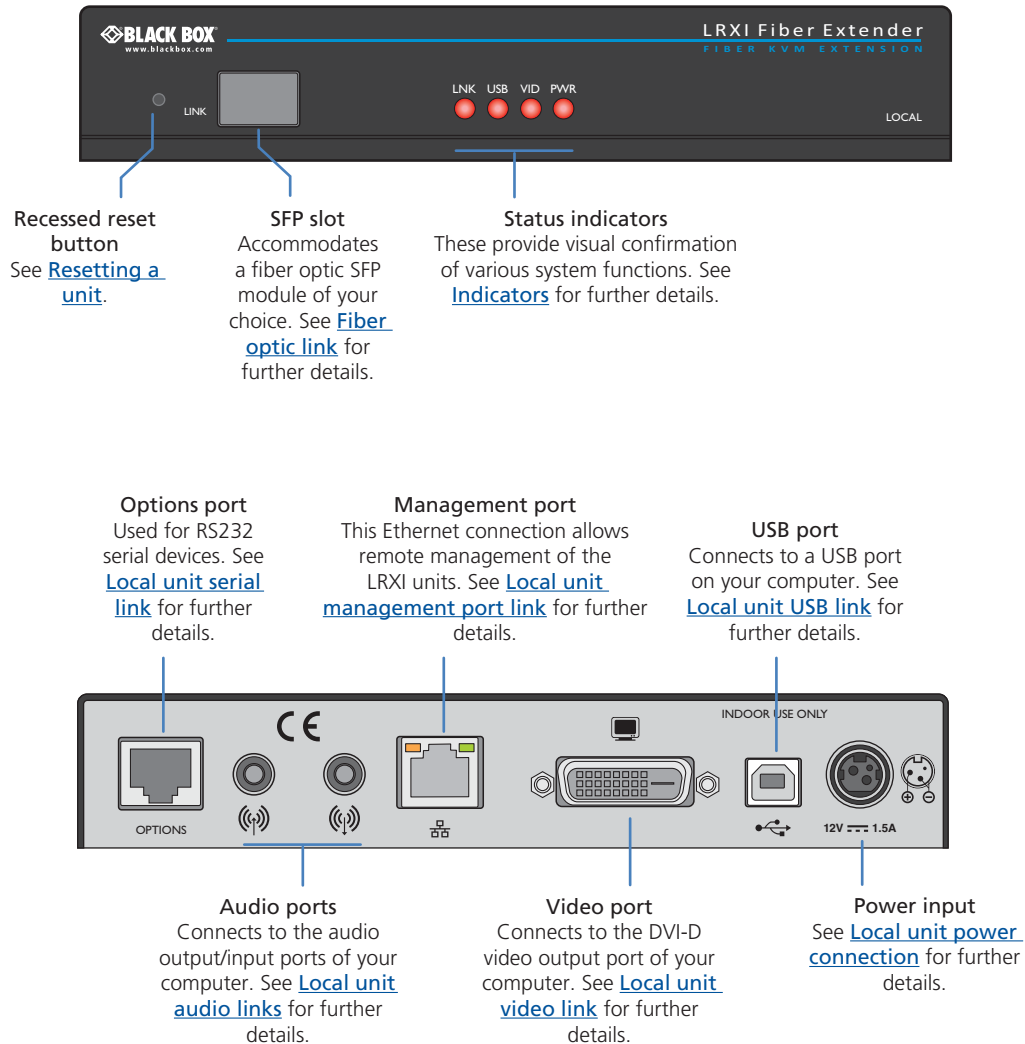

2.1.2 Remote unit

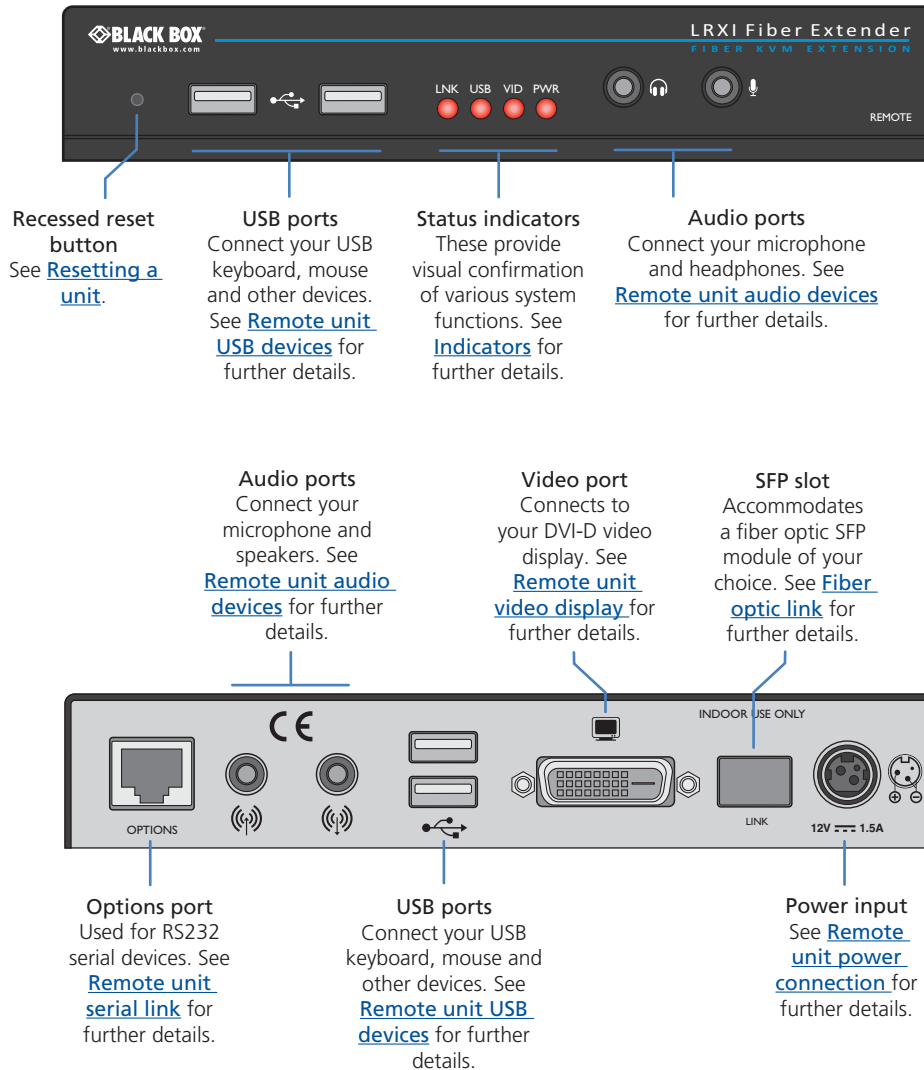

3. Locations

Please consider the following important points when planning the position of the LRXI Industrial Fiber Extender units:

- Situate the local unit close to the system to which it will be connected and near to a source of mains power. Place the remote unit in similar close proximity to the peripherals that it will connect with, plus a source of mains power.
- Consult the precautions listed within the [Safety information](#) section.
- Connections do not need to be carried out in the order given within this guide, however, where possible connect the power in as a final step.

3.1 Connections

Installation involves linking the LRXI Local unit to various ports on the host computer, while the LRXI Remote unit is attached to your peripherals.

3.2 Fiber optic link

Each pair of LRXI Industrial Fiber Extenders are supplied together with SFP fiber optic units of your choice (single or multi-mode). The fiber optic cable used must match the SFP type and also be of a suitable type for the distance being covered. See [Transmission distances](#) for details.

Note: In order to maintain a high level of confidence in the fiber optic link, the SFP's used must be those supplied by Black Box. If alternative parts are used, the system will detect this and will flash the front panel LNK indicator.

3.2.1 To make the fiber optic link

IMPORTANT: Ensure the power supply is off/disconnected before inserting or removing an SFP module.

- 1 Remove the SFP module from its protective packing and insert it fully into the empty slot on the LRXI unit. The LRXI local unit slot is located on the front panel; the LRXI remote unit slot is situated on the rear panel.

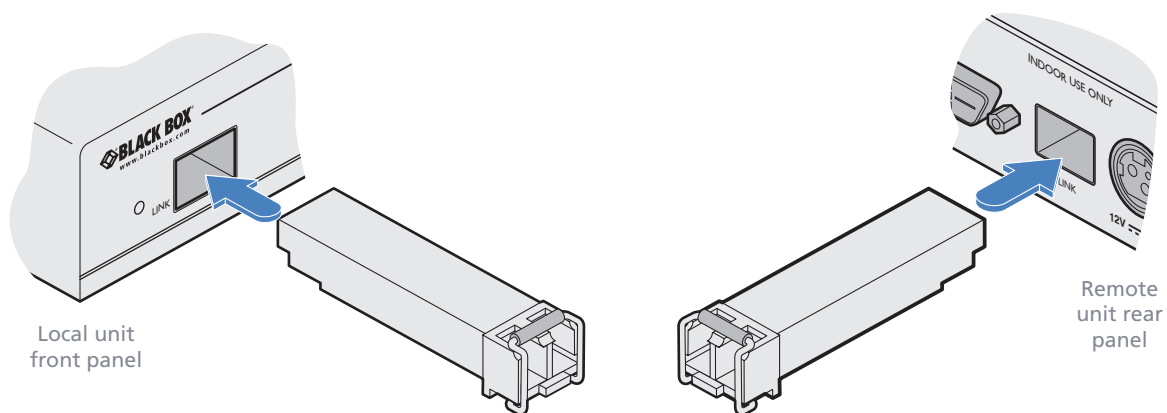

- 2 Repeat for the other SFP module on the other LRXI unit.
- 3 For each SFP module, remove the black rubber insert that protects the sensors.
- 4 If fitted, remove the dual inserts that protect the fiber optic connector.
- 5 Insert the fiber optic connector into the SFP module so that it clicks into place.

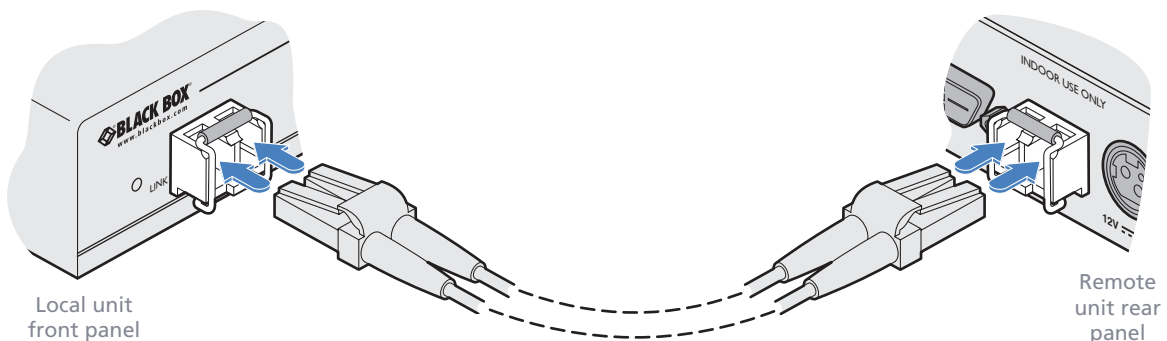

- 6 Repeat steps 4 and 5 at the other end.

3.2.2 To remove an SFP module

- 1 If fitted, remove the fiber optic connector from the SFP module (press down on the upper tab of the fiber optic connector to release it).
- 2 Unclip the small wire extraction lever and open it out (this action releases a locking tab and also provides a grip point).

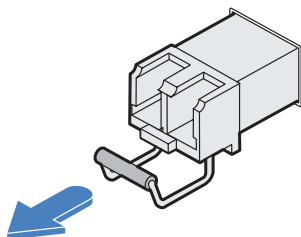

- 3 Gently pull on the extraction lever to withdraw the SFP module from the slot.
- 4 If the SFP module and/or fiber optic connector will remain unused for any period of time, be sure to fit the protective inserts to keep the optical interfaces clean.

3.3 Local unit video link

LRXI Industrial Fiber Extender units can support various high resolution video modes via the Dual-Link DVI-D port, see Video resolutions below for details.

3.3.1 To connect the video port

- 1 Connect the supplied digital video (plus USB) link cable between the DVI-D socket on the local unit rear panel and the DVI-D video output socket of the host computer.

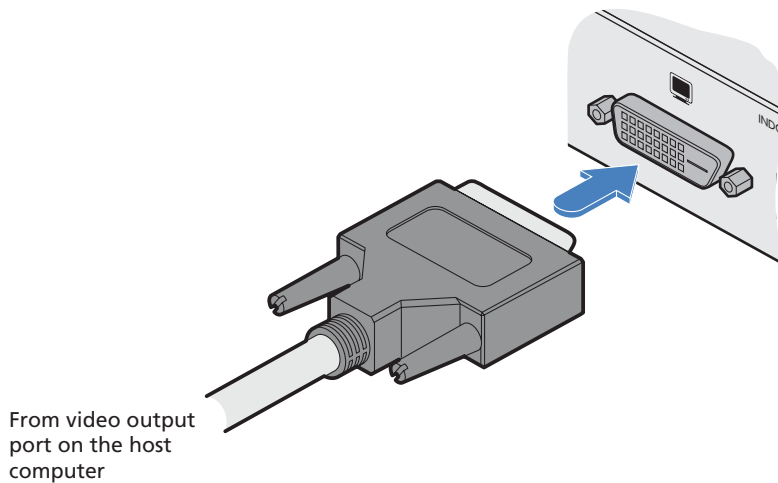

Video resolutions

The LRXI Industrial Fiber Extender units support, but are not limited to, the following common video resolutions:

- 1920 x 1080 (HD)
- 1920 x 1200 (WUXGA)
- 2560 x 1080
- 2560 x 1440 (WQHD)
- 2560 x 1600 (WQXGA)
- 2560 x 2048 (QSXGA)
- 2048 x 2160

3.4 Local unit audio links

The LRXI Industrial Fiber Extender units support stereo audio in and out connections. Where necessary, make connections between the audio input and/or output ports of the host computer and the local unit.

3.4.1 To connect the audio ports

- 1 For the line in and/or line out ports, connect the supplied audio link cable between the audio port on the local unit rear panel and the line in or line out socket of the host computer.

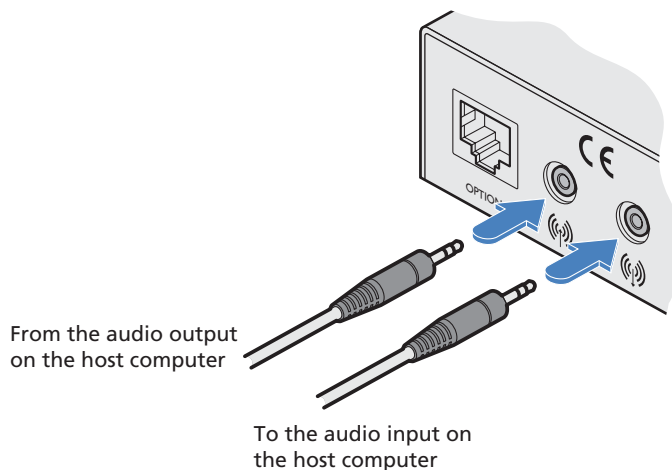

3.5 Local unit USB link

The local unit requires a single USB connection to the host computer; this allows the remote unit to operate as a USB 2.0 hub with four ports.

3.5.1 To connect the USB port

- 1 Connect the type B connector of the supplied USB/video cable to the USB port on the rear panel of the local unit.

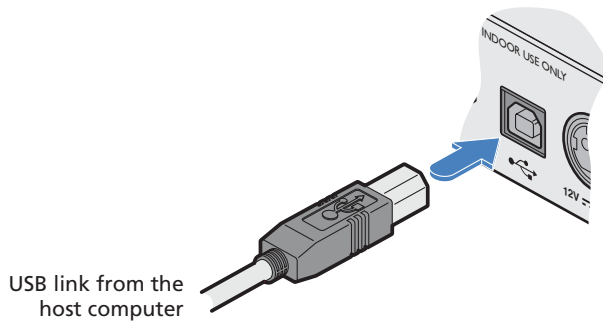

- 2 Connect the type A connector of the cable to a vacant USB port on the host computer.

3.6 Local unit serial link

The Options port provides an RS232 serial connection with the remote unit. When serial devices are attached to the Options ports on the local and remote units, the units transparently convey the signals between them, via the fiber optic link, at rates up to 115200 baud - no serial configuration is required. An optional serial cable is available from Black Box.

3.6.1 To connect the serial port

- 1 Use the optional serial cable to link the Options port on the rear panel of the local unit with a vacant RS232 serial port on your host computer.

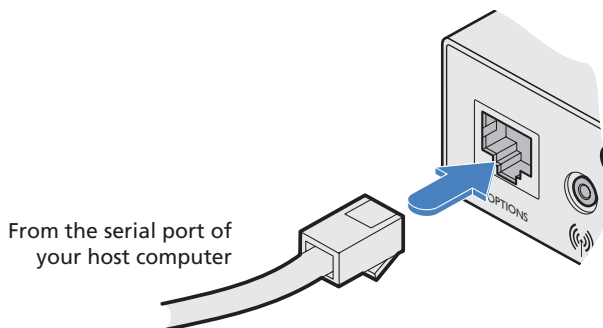

Please see [Appendix A](#) for pin-out details of the Options port.

3.7 Local unit management port link

The management port, located on the local unit, allows the unit to be connected to a standard Ethernet 10/100 network in order to allow remote monitoring and management functions to take place.

3.7.1 To connect the management port

- 1 Connect a standard CATx patch lead between the port on the rear panel of the local unit and a standard network switch.

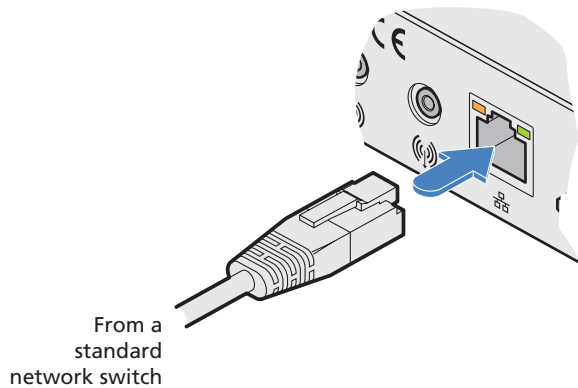

By default, the IP address is set to **192.168.1.22**. If required, you can change the default IP address or alternatively, choose automated address selection by DHCP server. For details, please see the Configuration section.

3.8 Local unit power connection

There is no on/off switch on either of the LRXI Industrial Fiber Extender units, so operation begins as soon as power is applied. The power adapters supplied with the units use locking-type plugs to help prevent accidental disconnections; please follow the instructions shown on the right whenever disconnecting a power adapter.

3.8.1 To connect the power adapter

1 Attach the output plug of the supplied power adapter to the power input socket on the right side of the rear panel.

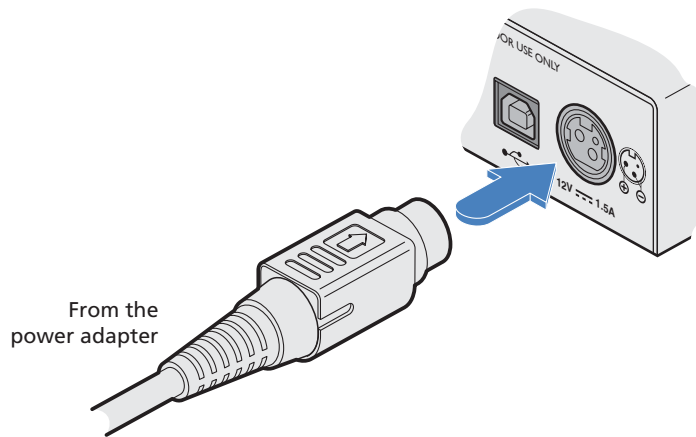

2 Connect the IEC connector of the supplied country-specific power cord to the socket of the power adapter.

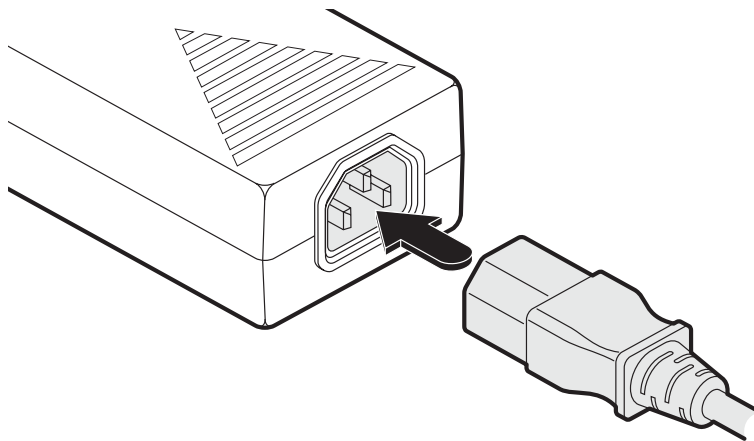

3 Connect the power cord to a nearby mains supply socket.

3.8.2 To disconnect the power adapter

- 1 Isolate the power adapter from the mains supply.
- 2 Grasp the outer body of the power adapter plug where it connects with the unit.
- 3 Gently pull the body of the outer plug away from the unit. As the body of the plug slides back, it will release from the socket and you can fully withdraw the whole plug.

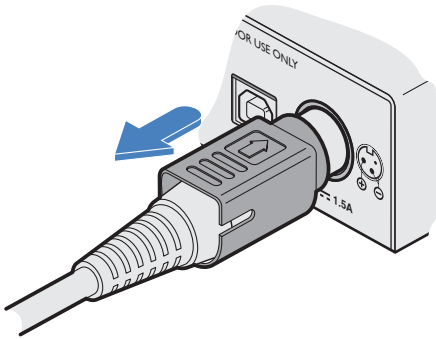

Gently pull back the plug outer body to release the lock

IMPORTANT: Please read and adhere to the electrical safety information given within the [Safety information](#) section of this guide. In particular, do not use an unearthed power socket or extension cable.

Note: Both the units and the power supplies generate heat when in operation and will become warm to the touch. Do not enclose them or place them in locations where air cannot circulate to cool the equipment. Do not operate the equipment in ambient temperatures exceeding 40 degrees Centigrade. Do not place the products in contact with equipment whose surface temperature exceeds 40 degrees Centigrade.

3.9 Remote unit video display

A Dual-Link DVI-D port is provided on the rear panel of the remote unit. The LRXI units can support various high resolution video modes, see [Video resolutions](#) for details.

3.9.1 To connect the video display

1 Connect the DVI-D video cable from your video display to the video output port on the rear panel of the remote unit.

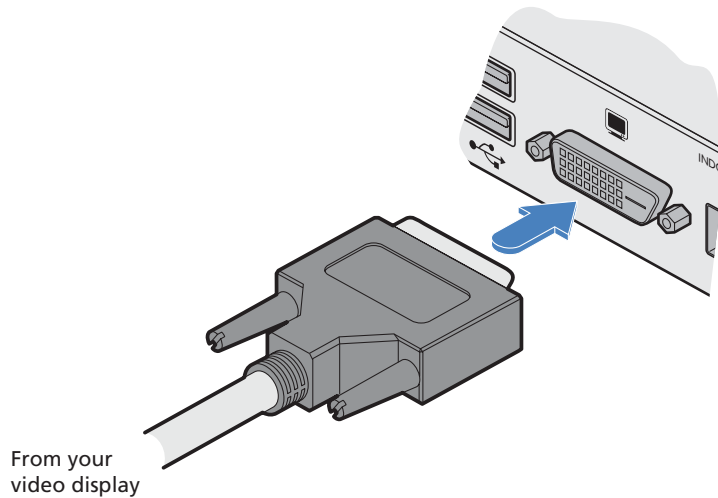

3.9.2 EDID management

The EDID (Extended Display Identification Data) is read from the connected video display at the remote unit; it is then transferred to, and stored within, the local unit and then declared to the host computer. If the video display is removed then the cloned EDID stored at the local unit will still be presented to the video source.

3.10 Remote unit audio devices

The LRXI Industrial Fiber remote unit can support multiple audio devices, such as stereo headphones, a mono microphone or line-level in/out connections.

3.10.1 To connect audio devices

- 1 Connect stereo headphones and/or a mono microphone to the 3.5mm jack audio sockets on the front panel of the remote unit.

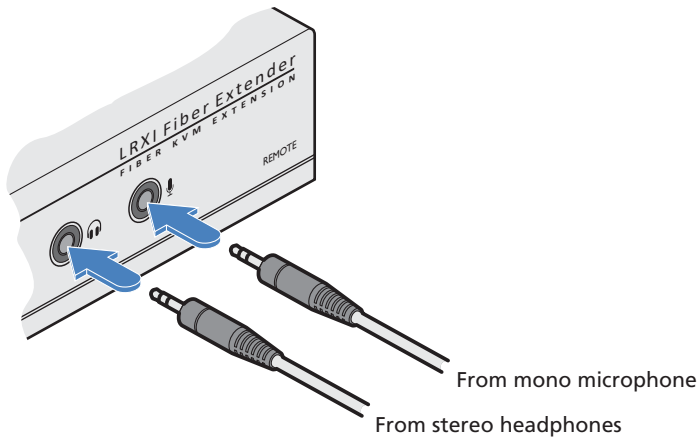

- 2 Optionally use the rear panel 3.5mm jack audio sockets to connect line-level in or out connections from audio devices, such as powered speakers.

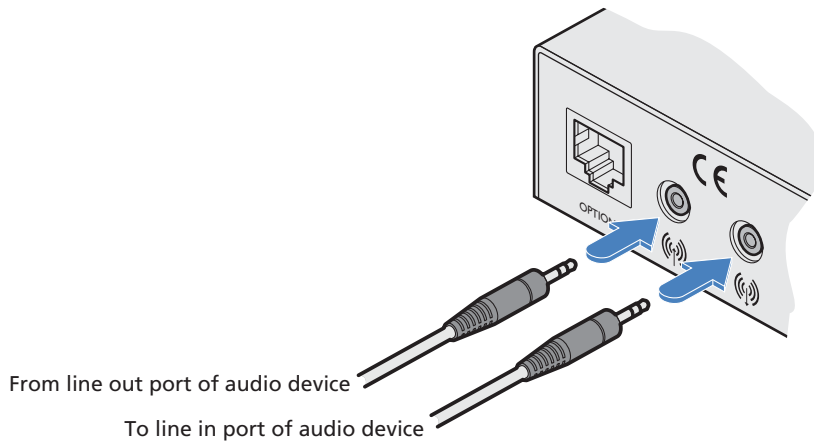

Note: If the microphone port on the front panel is used, the unit will disconnect the Line In port on the rear panel.

3.11 Remote unit USB devices

The remote unit contains a USB hub that can support up to four v2.0 or v1.1 USB devices (in any combination). All four USB sockets are identical in operation.

3.11.1 To connect USB devices

- 1 Connect your USB keyboard, mouse and any other two USB devices to the four sockets distributed on the front and rear panels of the remote unit.

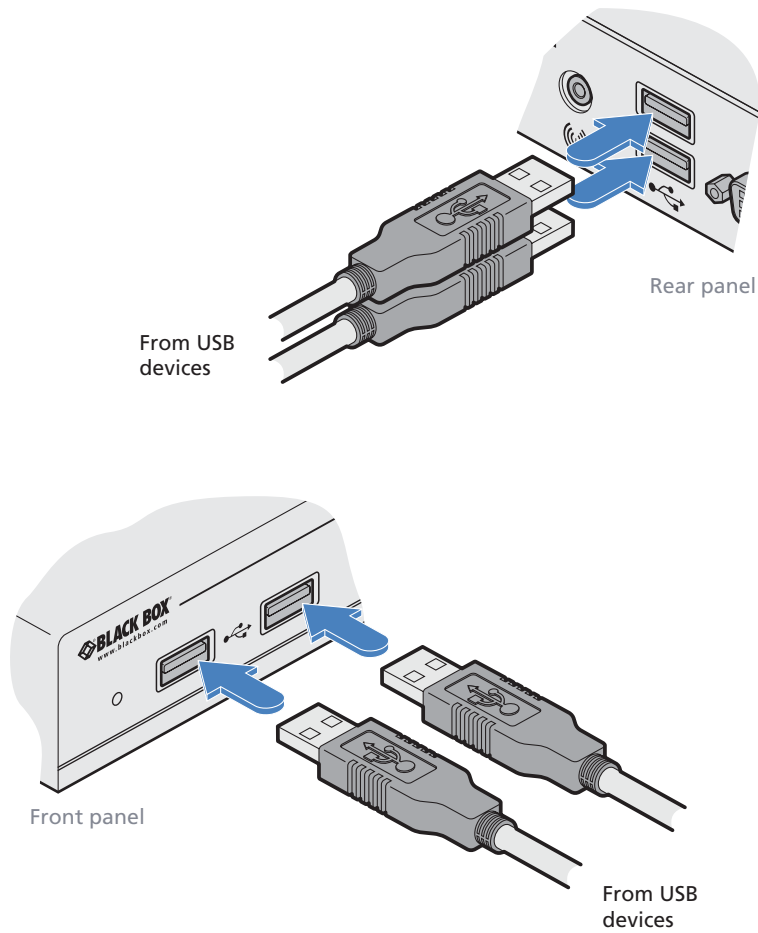

3.12 Remote unit serial link

The Options port provides an RS232 serial connection with the local unit. When serial devices are attached to the Options ports on the local and remote units, the units transparently convey the signals between them, via the fiber optic link, at rates up to 115200 baud - no serial configuration is required. An optional serial cable is available from Black Box.

3.12.1 To connect the serial port

1 Use the optional serial cable to link the Options port on the rear panel of the remote unit with your RS232 serial device.

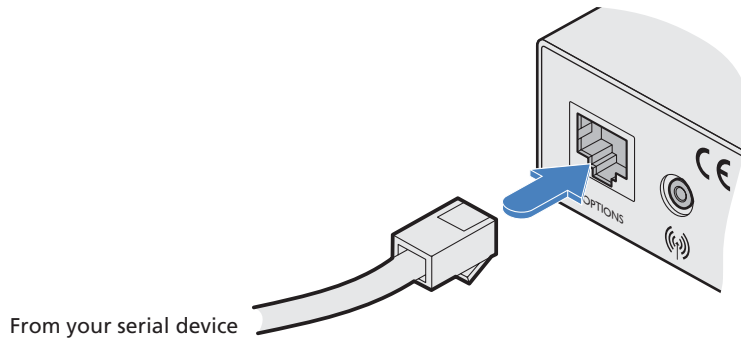

Please see [Appendix A](#) for pin-out details of the Options port.

3.13 Remote unit power connection

There is no on/off switch on either of the LRXI Industrial Fiber Extender units, so operation begins as soon as power is applied. The power adapters supplied with the units use locking-type plugs to help prevent accidental disconnections; please follow the instructions shown on the right whenever disconnecting a power adapter.

3.13.1 To connect the power adapter

1 Attach the output plug of the supplied power adapter to the power input socket on the right side of the rear panel.

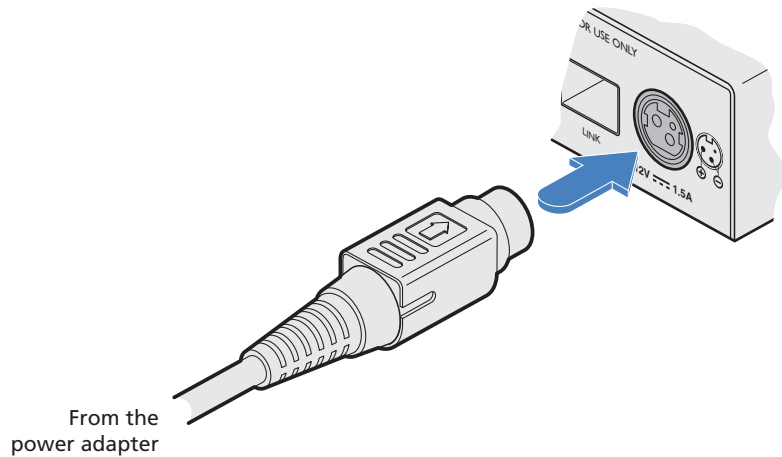

2 Connect the IEC connector of the supplied country-specific power cord to the socket of the power adapter.

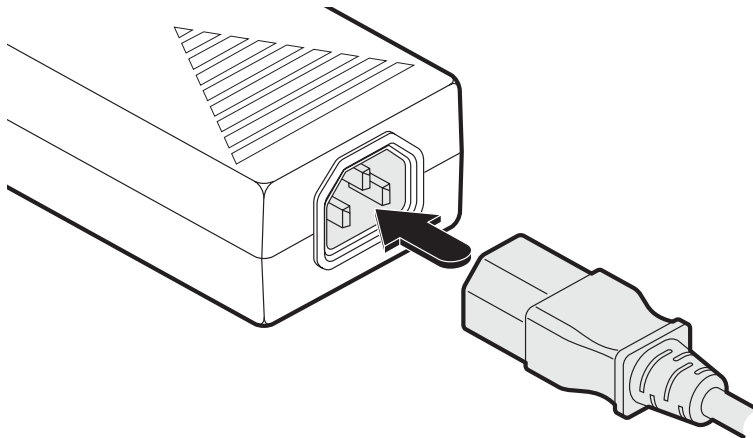

3 Connect the power cord to a nearby mains supply socket.

3.13.2 To disconnect the power adapter

- 1 Isolate the power adapter from the mains supply.
- 2 Grasp the outer body of the power adapter plug where it connects with the unit.
- 3 Gently pull the body of the outer plug away from the unit. As the body of the plug slides back, it will release from the socket and you can fully withdraw the whole plug.

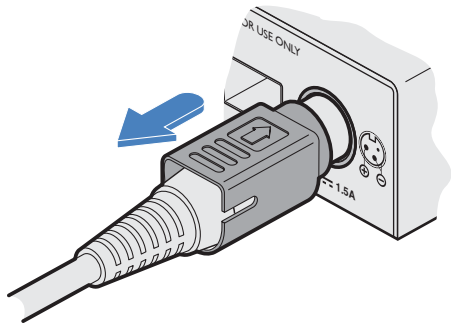

Gently pull back the plug outer body to release the lock

IMPORTANT: Please read and adhere to the electrical safety information given within the [Safety information](#) section of this guide. In particular, do not use an unearthed power socket or extension cable.

Note: Both the units and the power supplies generate heat when in operation and will become warm to the touch. Do not enclose them or place them in locations where air cannot circulate to cool the equipment. Do not operate the equipment in ambient temperatures exceeding 40 degrees Centigrade. Do not place the products in contact with equipment whose surface temperature exceeds 40 degrees Centigrade.

4. Accessing the management application

LRXI Industrial Fiber Extender units generally configure themselves automatically, collecting EDID information from the attached monitor and passing it to the host computer. In most cases the units will begin working together correctly as soon as they are connected. Where configuration changes are required (or remote monitoring is required), the management application provides an intuitive user interface.

4.1 To access the management application

- 1 Use a computer that is directly or indirectly (i.e. via a network switch) connected to the LRXI local unit. If you need to make a temporary connection, see below.
- 2 Run a web browser on your computer and enter the IP address of the local unit. By default, the IP address is set to **192.168.1.22**. If required, you can change the default IP address or alternatively, choose automated address selection by DHCP server. See the Configure page.
- 3 If requested, enter the registered password to log on.

Note: The default user and password are 'admin' and 'password' respectively.

The Dashboard page should be displayed:

The Dashboard page shows a real-time representation of the LRXI installation.

Use the menu on the left side to display other pages.

Use the Online Support option to make contact with Black Box through the main website.

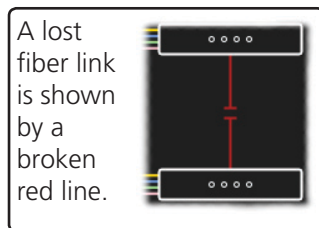
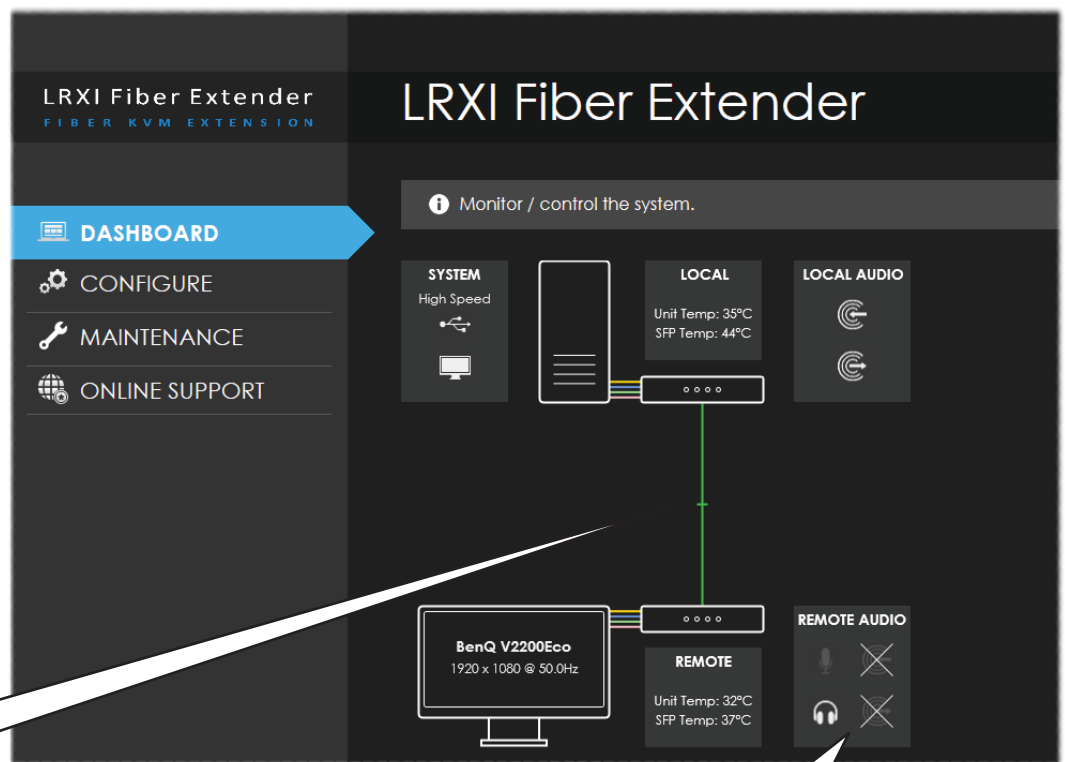

A lost fiber link is shown by a broken red line.

The appearance of the icons changes:

- White: Port is in use.
- Gray: Port not used.
- Gray with cross: Port is disabled.

4.2 To temporarily connect a computer to the network port

- 1 If you need to make a temporary connection for configuration purposes, use a standard patch cable (cross-over or straight connections are both supported) to link the Ethernet 10/100 network port (📏) on the rear panel of the LRXI local unit to your computer's network port.

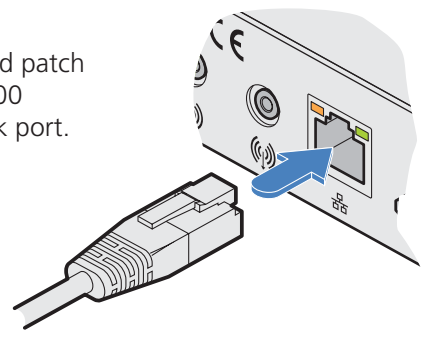

4.3 The Configure page

The Configure page allows you to control the various peripheral feeds and also determine the network addressing details.

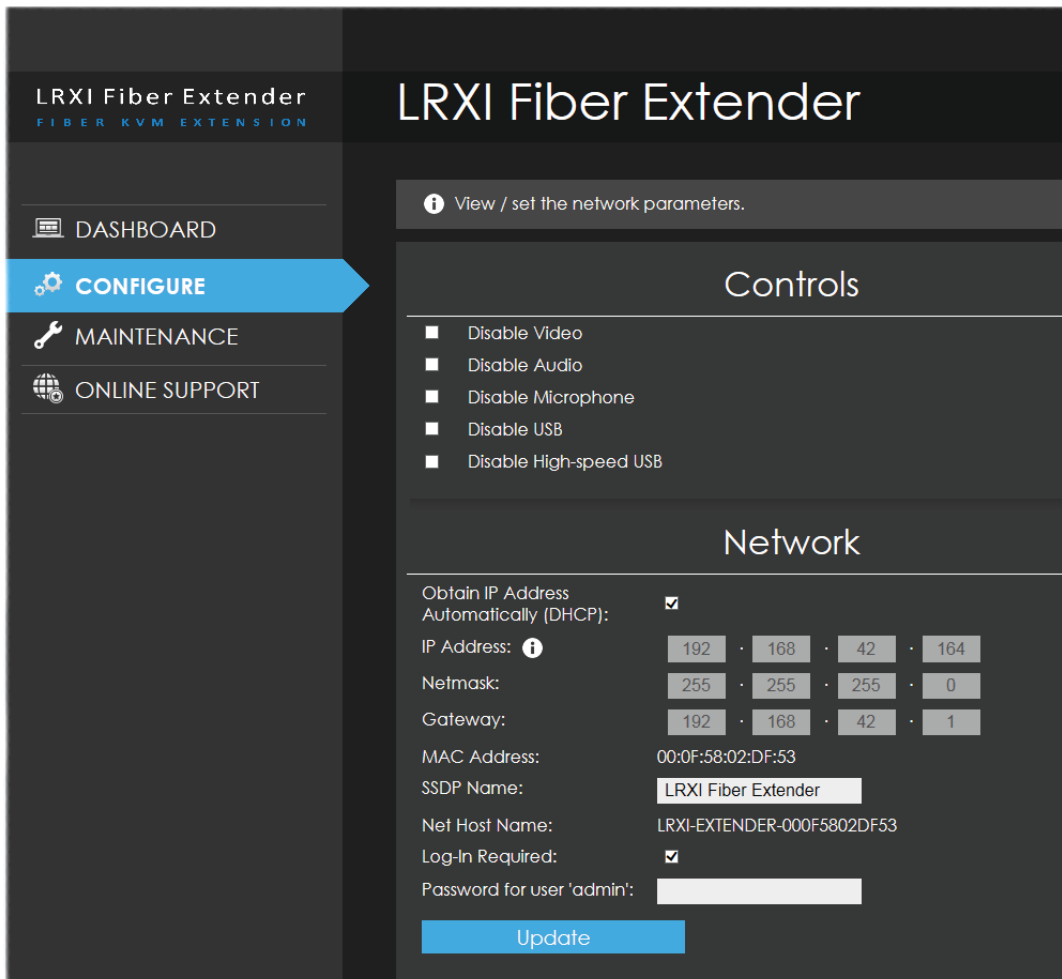

4.3.1 Controls

All peripheral feeds are enabled by default. However, this section allows each feed to be disabled as required.

- Disable High-speed USB - this option needs to be ticked when connecting to Black Box Freedom and/or Freedom II devices.

4.3.2 Network

- Obtain IP Address automatically (DHCP) - When ticked, the local unit will use the DHCP (Dynamic Host Configuration Protocol) to automatically determine all network settings. When DHCP is used, the next three options are not manually editable.
- IP Address - set the IP address for the unit.
- Netmask - set a subnet mask to accompany the IP address.
- Gateway - optionally define a suitable address for a gateway device.
- MAC Address - displays the unique (and fixed) MAC address for the unit.
- SSDP Name - optionally add an identifier for this unit.
- Log-in Required - when ticked, you will be requested to enter a user name and password.
- Password for user 'admin' - define a password here to be used when the 'Log In Required' option above is ticked.

Note: The default user name and password are 'admin' and 'password' respectively.

Once changes are made, click the Update button to apply them.

4.4 The Maintenance page

The Maintenance page contains numerous features used for monitoring, restarting and upgrading the units.

LRXI Fiber Extender
FIBER KVM EXTENSION

LRXI Fiber Extender

BLACK BOX

Restart, reset and firmware-update the device.

Local Unit

Firmware Version: 0.01.2166
Hardware Version: 1234A6789012 / M1a
Unit Temperature: 35°C
SFP Version: FINISAR CORP. / FTLF8524P2BNV / PSM1GZU
SFP Temperature: 43°C
Up-Time: 15 hours, 38 minutes, 29 seconds

Remote Unit

Firmware Version: 0.01.2166
Hardware Version: 1234A6789012 / M1a
Unit Temperature: 32°C
SFP Version: FINISAR CORP. / FTLF8524P2BNV / PV31S1D
SFP Temperature: 36°C
Up-Time: 15 hours, 38 minutes, 33 seconds

EDID

Monitor: BenQ V2200Eco
Serial Number: A4A00114026
Raw: 00 ff ff ff ff ff ff 00 09 d1 04
7d 45 54 00 00 0e 14 01 03 80 30
1f 13 14 05 23 09 07 83 01 00
00 00 20 39 40 de 0e 11 00 00 1e
00 00 bf

Identify

Flash LED

Restart

Local Unit Restart

Identify

Flash LED

Restart

Remote Unit Restart

Factory Reset

WARNING: This operation will perform a full factory reset on both the remote unit and the local unit. This will set the IP Address to 192.168.1.22.

Factory Reset

Link Quality Test

100%

Link Quality Test

Firmware Upgrade

NOTE: To complete the upgrade, you may need to restart the browser or delete this app. from the browser's history.

No upgrade file is selected

Select Firmware File

4.4.1 Local and remote unit details

These twin sections list numerous details for each unit:

- Firmware, hardware and SFP (optical module) versions.
- Unit (main circuit board) and SFP (optical module) temperatures.
- Up-time.
- EDID - lists the currently registered video monitor, together with its serial number and a full raw hex listing of the declared EDID signature.
- Identify - Click the Flash LED button to flash the front panel indicators of the chosen unit. Click once for five flashes, twice for indefinite flashing and a third time to stop the flashing.
- Restart - If a unit becomes unresponsive, click the relevant Restart button to reboot the required unit.

4.4.2 Factory Reset

Click this button to perform a full factory reset on both units. All settings will be returned to their default values; the local unit will default to use the IP address of **192.168.1.22**.

4.4.3 Link Quality Test

This section tests and displays the quality of the data link between the two units.

4.4.4 Firmware Upgrade

Use this section to perform a firmware upgrade on both units using files available on request from Black Box technical support.

Note: Firmware upgrades must be performed in pairs, i.e. the local unit and remote unit together. If one of the units is not connected, the upgrade will not be carried out.

4.4.5 Download the API description

Click here to view the API description in *YAML* format.

5. Operation

The LRXI Industrial Fiber Extender units are designed to be transparent in operation; all peripherals should respond exactly as they would when situated next to your host computer.

5.1 Indicators

The local and remote units contain various indicators to provide you with status information. Both units have four red indicators on their front panels.

5.1.1 Red status indicators

The red status indicators on the front panels of each unit mostly behave in the same manner at the same time:

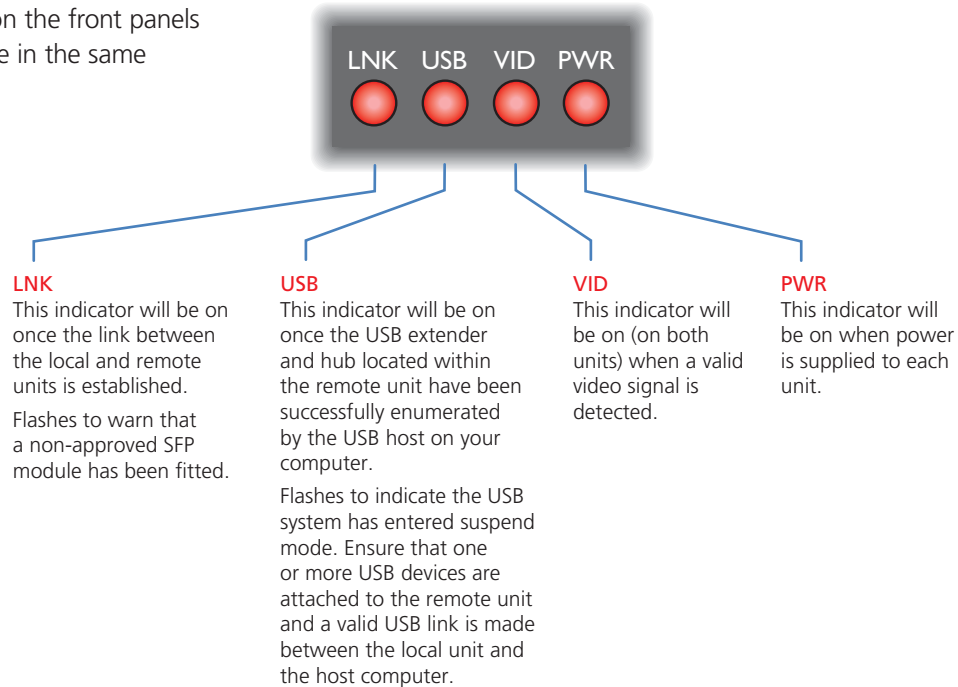

5.1.2 Green and amber status indicators (local unit only)

The green and amber status indicators on the network management port connector of the local unit (rear panel) provide further status information:

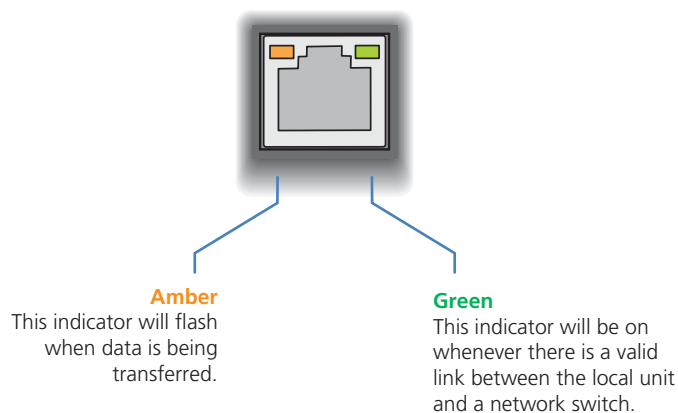

5.2 Resetting a unit

On the left side of the front panel of each unit, you will find a small hole which is used to invoke special functions. Use a thin implement, such as a straightened paperclip to press and hold the button concealed behind the smaller hole. Depending on when you release the button, the unit will either perform a normal reset or completely reset itself to factory defaults:

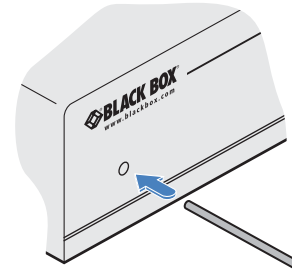

Time (seconds):	0	5	10	15
Indicator(s):	PWR: On	All: Alternate flashing	All: Rapid flashing together	All: Normal
Release button for:	<i>Normal restart</i>	<i>Special configuration option (not currently used)</i>	<i>Reset to factory defaults</i>	<i>Return to normal operation</i>

Appendix A. Options port pin-out

The OPTIONS port uses a 6p6c socket. The pin-out is listed below.

Note: Although the pin labeled 'Not used' is inactive, it is still connected internally and so no links should be made at all to this pin.

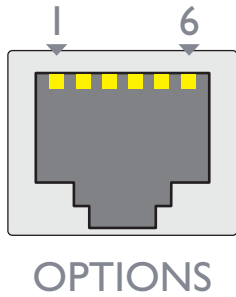

Pin	Signal	Direction
1	CTS1 / RXD2	Input to the unit
2	RXD1	Input to the unit
3	TXD1	Output from the unit
4	RTS1 / TXD2	Output from the unit
5	Not used	
6	GND	Reference for all signals

Appendix B. Open source licenses

This product includes binaries that are derived from the open source community.

=====

lwIP is licenced under the BSD licence:

Copyright (c) 2001-2004 Swedish Institute of Computer Science.

All rights reserved.

Redistribution and use in source and binary forms, with or without modification, are permitted provided that the following conditions are met:

1. Redistributions of source code must retain the above copyright notice, this list of conditions and the following disclaimer.
2. Redistributions in binary form must reproduce the above copyright notice, this list of conditions and the following disclaimer in the documentation and/or other materials provided with the distribution.
3. The name of the author may not be used to endorse or promote products derived from this software without specific prior written permission.

THIS SOFTWARE IS PROVIDED BY THE AUTHOR "AS IS" AND ANY EXPRESS OR IMPLIED WARRANTIES, INCLUDING, BUT NOT LIMITED TO, THE IMPLIED WARRANTIES OF MERCHANTABILITY AND FITNESS FOR A PARTICULAR PURPOSE ARE DISCLAIMED. IN NO EVENT SHALL THE AUTHOR BE LIABLE FOR ANY DIRECT, INDIRECT, INCIDENTAL, SPECIAL, EXEMPLARY, OR CONSEQUENTIAL DAMAGES (INCLUDING, BUT NOT LIMITED TO, PROCUREMENT OF SUBSTITUTE GOODS OR SERVICES; LOSS OF USE, DATA, OR PROFITS; OR BUSINESS INTERRUPTION) HOWEVER CAUSED AND ON ANY THEORY OF LIABILITY, WHETHER IN CONTRACT, STRICT LIABILITY, OR TORT (INCLUDING NEGLIGENCE OR OTHERWISE) ARISING IN ANY WAY OUT OF THE USE OF THIS SOFTWARE, EVEN IF ADVISED OF THE POSSIBILITY OF SUCH DAMAGE.

=====

jsmn is licenced under the MIT license:

Copyright (c) 2010 Serge A. Zaitsev

Permission is hereby granted, free of charge, to any person obtaining a copy of this software and associated documentation files (the "Software"), to deal in the Software without restriction, including without limitation the rights to use, copy, modify, merge, publish, distribute, sublicense, and/or sell copies of the Software, and to permit persons to whom the Software is furnished to do so, subject to the following conditions:

The above copyright notice and this permission notice shall be included in all copies or substantial portions of the Software.

THE SOFTWARE IS PROVIDED "AS IS", WITHOUT WARRANTY OF ANY KIND, EXPRESS OR IMPLIED, INCLUDING BUT NOT LIMITED TO THE WARRANTIES OF MERCHANTABILITY, FITNESS FOR A PARTICULAR PURPOSE AND NON-INFRINGEMENT. IN NO EVENT SHALL THE AUTHORS OR COPYRIGHT HOLDERS BE LIABLE FOR ANY CLAIM, DAMAGES OR OTHER LIABILITY, WHETHER IN AN ACTION OF CONTRACT, TORT OR OTHERWISE, ARISING FROM, OUT OF OR IN CONNECTION WITH THE SOFTWARE OR THE USE OR OTHER DEALINGS IN THE SOFTWARE.

Appendix C. Safety Information

- For use in dry, oil free indoor environments only.
- Do not use to link between buildings.
- Ensure that the twisted pair interconnect cable is installed in compliance with all applicable wiring regulations.
- Do not connect the CATx link interface (RJ45 style connector) to any other equipment, particularly network or telecommunications equipment.
- Warning – the power adapter contains live parts.
- No user serviceable parts are contained within the power adapter - do not dismantle.
- Plug the power adapter into a grounded socket outlet close to the unit that it is powering.
- Replace the power adapter with a manufacturer approved type only.
- Do not use the power adapter if the power adapter case becomes damaged, cracked or broken or if you suspect that it is not operating properly.
- If you use a power extension cord with the units, make sure the total ampere rating of the devices plugged into the extension cord do not exceed the cord's ampere rating. Also, make sure that the total ampere rating of all the devices plugged into the wall outlet does not exceed the wall outlet's ampere rating.
- Do not attempt to service the units yourself.
- The units and power supplies can get warm in operation – do not situate them in an enclosed space without any ventilation.
- The units do not provide ground isolation and should not be used for any applications that require ground isolation or galvanic isolation.

Black Box Tech Support: FREE! Live. 24/7.

Tech support the
way it should be.



Great tech support is just 60 seconds away at [877-877-2269](tel:877-877-2269) or blackbox.com.



About Black Box

Black Box provides an extensive range of networking and infrastructure products. You'll find everything from cabinets and racks and power and surge protection products to media converters and Ethernet switches all supported by free, live 24/7 Tech support available in 60 seconds or less.

© Copyright 2020. Black Box Corporation. All rights reserved. Black Box® and the Double Diamond logo are registered trademarks of BB Technologies, Inc. Any third-party trademarks appearing in this manual are acknowledged to be the property of their respective owners.

ACU5600A, rev. 1.1